

Programmable Controller

FP0R SERIES



The New Standard of Ultra-compact PLCs

NEW

Equipped with RS485 Port

Largest in its class *1

Large Capacity Program and Data Memory

Fastest in its class *1

Ultra-high Speed Processing

Multi-axis Control available without Expansion

Industry's First *2

Battery-less Automatic Backup of All Data



*1. Among compact PLCs with up to 128 I/O points based on our research as of July 1, 2011

*2. Based on our research as of July 1, 2011



Our Mission is to Maximize Customer Benefits with Enhancing Advanced Functionality and Performance.

The Answer is **FPO_R**, Superior to Basic Ultra-

Smallest in its class *1

The control unit is small at 90 mm 3.54 in in height and 25 mm 0.98 in in width. Even when expanded with three expansion units, the total width only 100 mm

The ultra-compact space-saving body size facilitates the miniaturization of target machines, equipment, and control panels.

Ultra compact
I/O points **Min. 10 points**
Max. 128 points

The number of I/O points is expandable up to 128 by adding three expansion units having 32 I/O points each to one control unit equipped with 32 I/O points.

Input/Output terminals

Only one cable is required for communications with the "Control FPCWIN Pro" or "Control FPCWIN GR" programming tool.

Tool ports

Equipped with both USB 2.0 and RS232C ports.

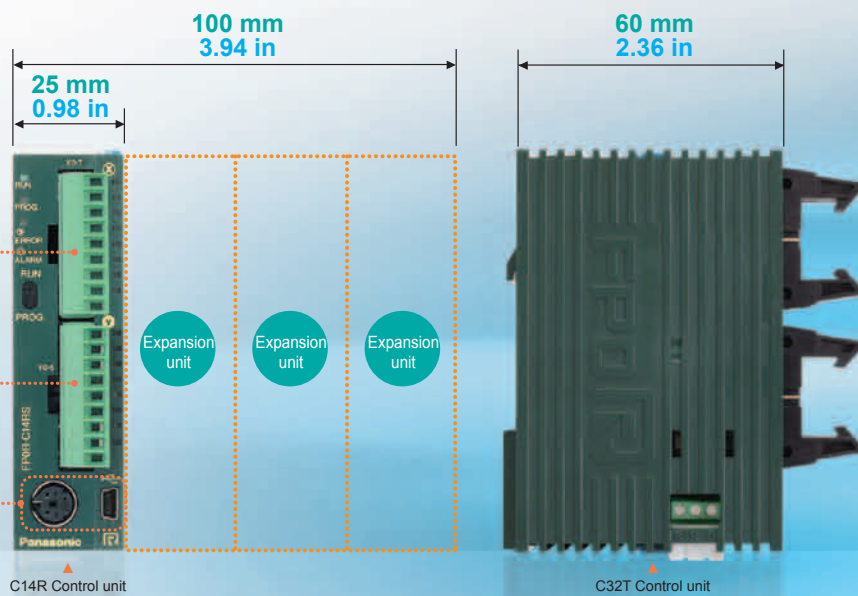

Multi-axis (4-axis) control is available without expansion units.

The built-in 4-axis pulse outputs allow multi-axis motor control without positioning units or other expansion units.

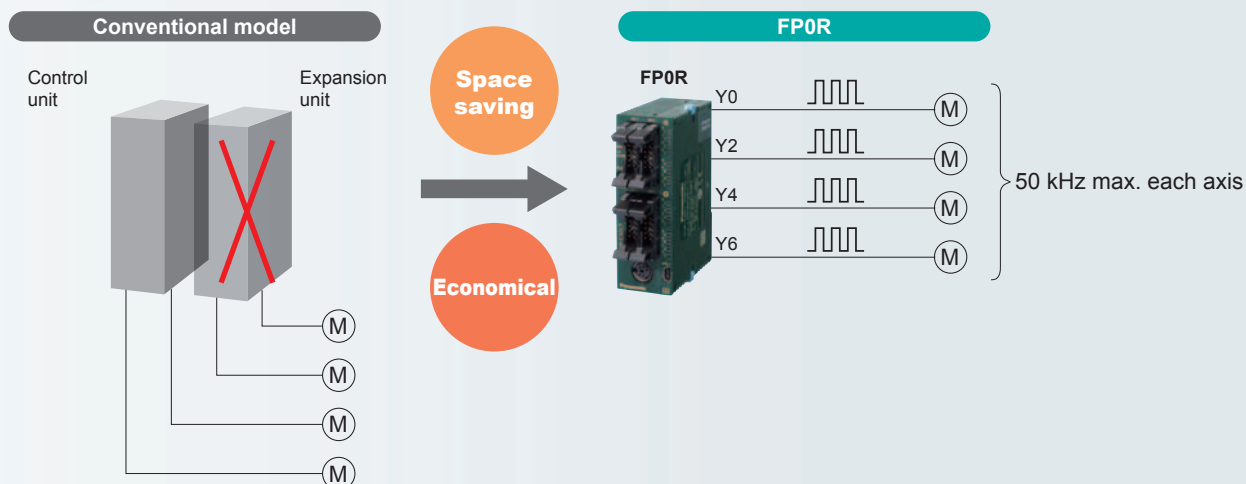

Outstanding Products



Worldwide simultaneous launch of the 3-year warranty
 For details, visit the following website:
panasonic-denko.co.jp/ac/e/fasys/warranty

compact Models.

3.94 in.



Industry's First *

Battery-less automatic backup of all data

The F type (FP0R-F32) has a built-in FeRAM, which is a cutting-edge device that allows the automatic saving of all data without a backup battery.

- There is no need to worry about data loss after a long vacation.
- Battery replacement is no longer necessary when shipping or transferring the unit overseas.
- Replacement of equipment and restoration of idle equipment is easy.
- The unit can be powered off flexibly on weekends or at other non-operating times, promoting energy saving.

* Based on our research as of July 1, 2011

NEW

Equipped with RS485 port

Up to 99 units can be connected, expanding applications for the eco-conscious business field.
 The PLC link is available with up to 16 other FP series and FP0R units.

Fastest in its class *1

Ultra-high speed processing

Ultra-high speed: 80 ns/step (ST instructions)
 * Within a range of 0 to 3,000 steps. Processing of the 3,001st and later steps is 580 ns, 1.5 times faster than the conventional model.

Note: Unit expansion increases the base time.

| |
|--|
| Base scan time: I/O refresh + base time |
|--|

Without expansion units: 0.2 ms or less
 With expansion units: 0.2 ms or less + (1 x Number of expansion units) ms

Large capacity independent comment memory

Program maintenance and management become easier.

USB tool port provided as standard equipment

Programming work becomes simpler, easier, and quicker, improving the production efficiency.

Full-fledged positioning functions

A variety of dedicated instructions enable high-accuracy positioning.

Largest in its class *1

Large capacity program

Program capacity: 32 k steps *2
 Data register: 32 k words *2

*1 Among compact PLCs with up to 128 I/O points based on our research as of July 1, 2011
 *2 C10, C14 or C16 control unit: Program capacity of 16 k steps and data register of 12 k words

POSITIONING

Jog positioning control (F171 instruction)

The motion can be started without a preset target value. When a stop signal is input, the target value is set, and the motion is slowed to a stop.

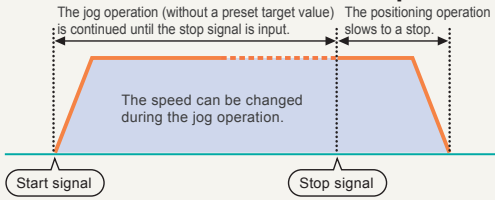

Useful for

- Labelers: Stopping the motion at a constant distance from the point where a label end detection signal is triggered
- Processing machines: Stopping the motion at a constant distance from the point where a processing object edge detection signal is triggered, and cut/drill the object

Changing the speed (available for F171 and F172 instructions)

The target speed can be changed by an external signal input during the jog operation or trapezoidal control operation.

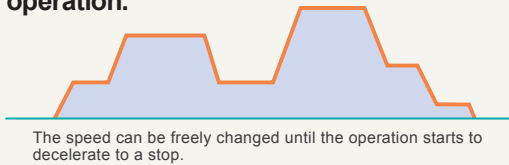

Useful for

- Speed synchronization of transfer or processing equipment.

Built-in 4-axis pulse outputs (Transistor output type)

Two sets can simultaneously undergo two-axis linear interpolation.

No complicated speed calculation or programming is required. Two-axis linear interpolation is available by using the F175 dedicated instruction. Two sets such as two X-Y tables, for example, can be simultaneously controlled.

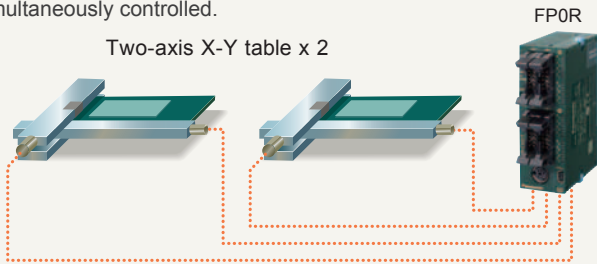

Built-in multipoint PWM outputs (4 channels)

The pulse output port of FP0R can also serve as a PWM output port. One of the application examples is an analog voltage output, which can be used for inverter speed control.

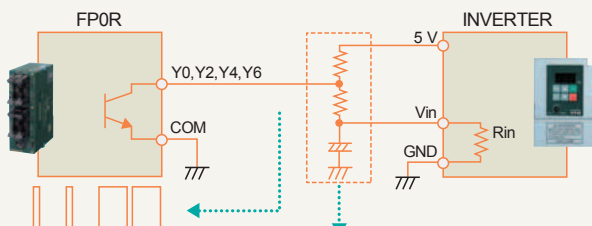

The speed can be controlled by changing the ON width of the PWM output.

The unit can also serve as an analog voltage output when a smoothing capacitor is inserted in the circuit.

Individual settings for acceleration and deceleration (available for F171, F172, and F174 instructions)

The acceleration time and deceleration time can be individually set.

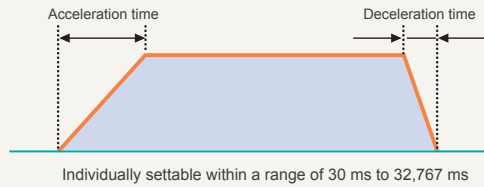

Useful for

- Labelers: Starting the operation at a relatively low acceleration to prevent tape from breaking. Stopping the operation at high deceleration when detecting the label end to save the tape
- Lifts: Optimizing the acceleration and deceleration during ascending and descending transfers.

Measuring the pulse frequency (F178 instruction)

Pulses input in a specified period by a single instruction are counted, and the frequency is calculated.

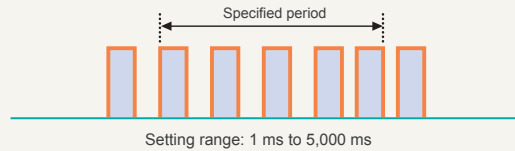

Useful for

- Detection of motor rotation speed for encoder feedback control

High-speed counters and pulse outputs

Ladder programs can be combined to create an application for counting pulse signals from the encoder through the high-speed counter input and adjusting the pulse output frequency based on the count to synchronize the slave axis speed with the master axis speed.

In the right-hand figure, the speed of conveyor 1, which is inverter-controlled, is measured based on the encoder pulse count, and pulses are output to the slave motor (for jog operation) according to the measured speed in order to synchronize the speed of conveyor 2.

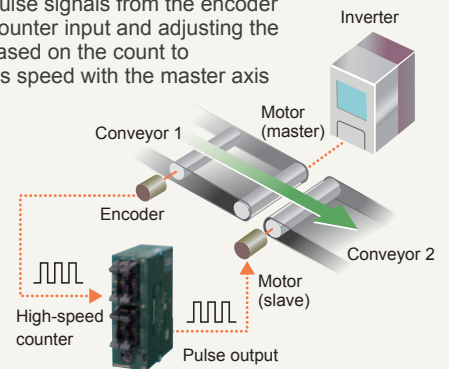

■ PLC link (MEWNET-W0)

Contact data can be shared among up to 16 PLC units, including FP0R, FPΣ, FP-X, FP2/FP2SH, and a mixture of them, without the need for programs.

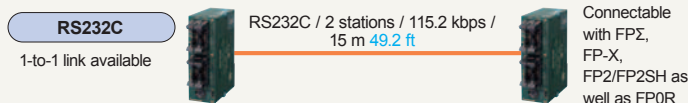

Application examples

Use two FP0R units to control the assembly and transfer sections of a small machine respectively, connect them via the PLC link, and share one display

RS485

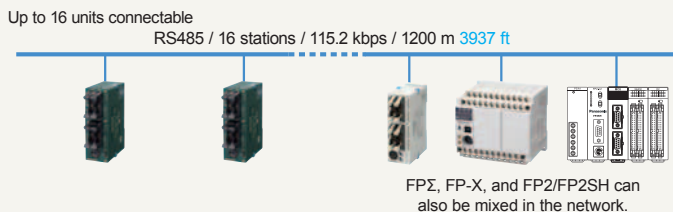

Application examples

Management of manufacturing line operations

■ RS485 serial communication

Compatible with both Modbus master and slave RTU.

This feature expands applications for the eco-conscious business field, and is ideal for the control of air conditioners, temperature, and electrical power.

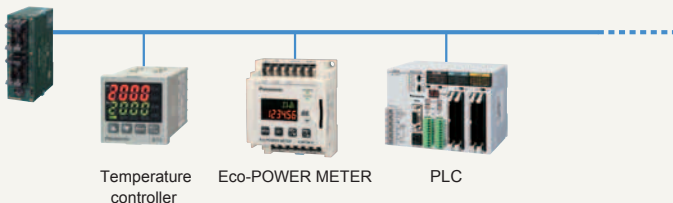

• Up to 99 units can be connected.

When 17 or more FP series units need to be linked, you can link up to 99 units by using the Modbus function instead of MEWNET-W0. Since each FP0R unit can be either a master or a slave, a multi-master link can be created by passing a token from a user program.

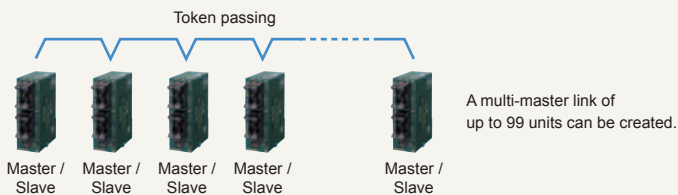

■ CC-Link slave unit

This unit is compatible with CC-Link, which is an open network, and capable of reading/writing four-word data through a maximum of 16 input and 16 output points.

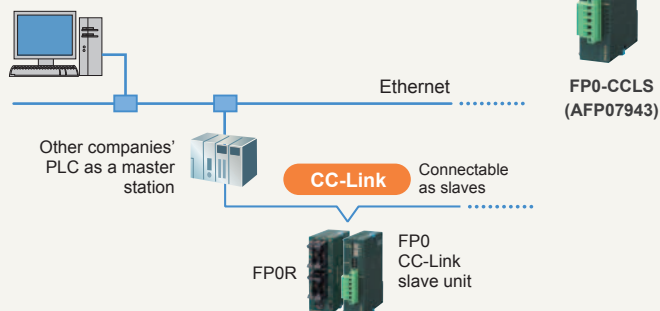

■ FP Web-Server2

The FP0R operation status can be monitored on a Web browser.

The FP0R operation status can be monitored on a Web browser by connecting FP Web-Server2 and FP0R via RS232C and making required settings using dedicated software (FP Web Configurator Tool 2).



FP Web-Server2 (AFP0611)

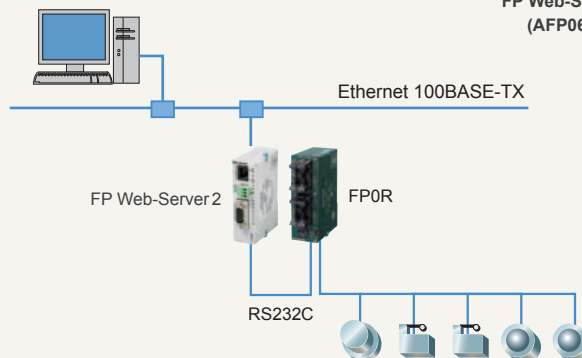

■ RS232C general-purpose serial communications

The control unit has an RS232C port for serial communications.

The RS232C port allows for direct connection to an operation display panel or a PC. Also, it facilitates bi-directional data communications with bar-code readers and other RS232C devices.

- * The port block has S, R, and G terminals for connection. Operation display panels can also be connected to the tool port.
- * Both the relay output and transistor output types of control unit equipped with an RS232C port are available.

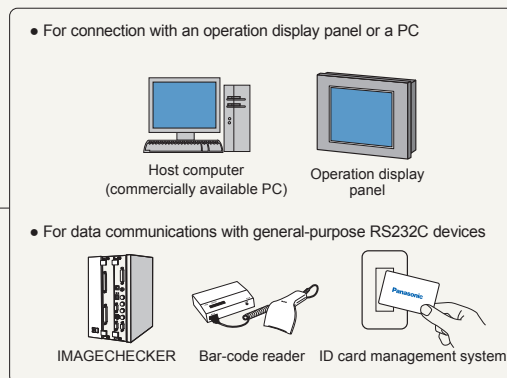

■ I/O link unit

This link unit enables FP0R to serve as a slave station of MEWNET-F (remote I/O system) and exchange I/O data from 32 input points and 32 output points with a master station without the need for programs.

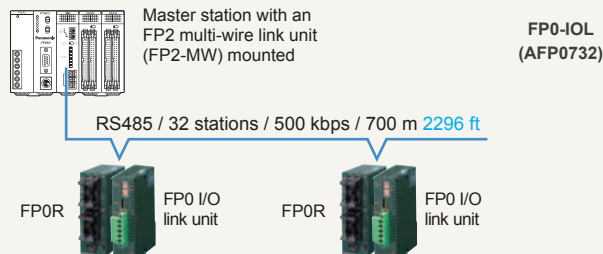

OTHER USEFUL FUNCTIONS

Program protection

Program upload protection setting

User programs can be protected from unauthorized copying by disabling program upload using our software, FPCWIN. This function is useful for users who manage original programs on a PC.

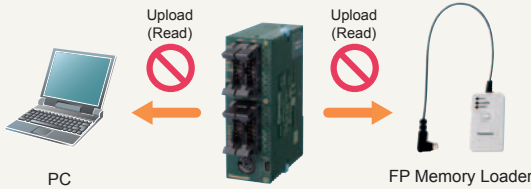

Eight-character password

Since uppercase and lowercase alphanumeric characters can be used, there are approx. 218 trillion possible password combinations. If an incorrect password is entered three times in a row, a cold reboot is required. This function is useful for users who upload programs from FP0R.

Temperature controller

- A temperature control program can be written in only one line by using a PID instruction (F356 EZPID), facilitating temperature control programming by a PLC, which had previously been considered difficult.
- The total accuracy is $\pm 0.8^{\circ}\text{C}$ $\pm 33.44^{\circ}\text{F}$ (K, J and T range). Two types are available: 4-channel and 8-channel types. Up to three units can be connected, allowing high-accuracy multi-point PID control of a maximum of 24 channels.

Thermocouple unit



4ch AFP0420 (FP0-TC4) 8ch AFP0421 (FP0-TC8)

Built-in real-time clock (T type only)

The clock allows for year, month, day, hour, minute, and second data processing. The clock data can be linked to periodic monitoring of production data and operation status, and the management of error history records.

Interrupt input

This function takes in input signals at high speed regardless of the scan time and instantly executes the interrupt program. This is useful for high-accuracy positioning control or control of defective item ejector valves. The X0 to X7 inputs can be designated as interrupt inputs (C10: X0 to X5).

Pulse catch

This function can take in 10 μs short pulse inputs and is therefore ideal for taking in signals from a sensor to detect small components.

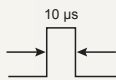





The X0 to X7 inputs can be designated as pulse catch inputs.

Analog I/O

The lineup includes a compact analog I/O unit with one analog output and two analog input channels, an A/D converter unit with eight analog input channels, and a D/A converter unit with four analog output channels. Communication using up to 24 channels is possible. Both the compact body size and the high input/output resolution of 1/4,000 (12 bits) have been achieved. The DIP switches in the unit cover a variety of input/output ranges and are user-friendly.

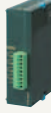

| Analog I/O unit | A/D converter unit | D/A converter unit | D/A converter unit |
|---|---|---|---|
| Input: 2ch / Output: 1ch | Input: 8ch | Voltage output: 4ch | Current output: 4ch |
|  |  |  |  |
| AFP0480 (FP0-A21) | AFP0401 (FP0-A80) | AFP04121 (FP0-A04V) | AFP04123 (FP0-A04I) |

EEPROM data saving (F12 and P13 instructions)

All FP0R series models are equipped with EEPROM, which can electrically rewrite data and retain data without the need for voltage supply. Setting data and production result data can be written and saved by the P13 instruction, and read out by the F12 instruction when necessary.



Note: Each block is limited to 10,000 write operations.

Program download in RUN mode (Comment writable)

Even while the equipment is operating with FP0R in RUN mode, a whole program edited offline can be downloaded to FP0R, and comments can be written simultaneously. Programs can be changed without stopping a running production line.

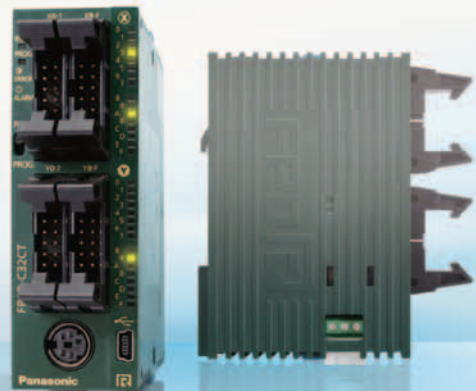
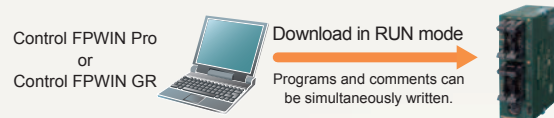

PROGRAMMING SOFTWARE

Control FPCWIN Pro (IEC61131-3 compliant Windows version software)

Compliant with international standard IEC61131-3
Programming software approved by PLC Open

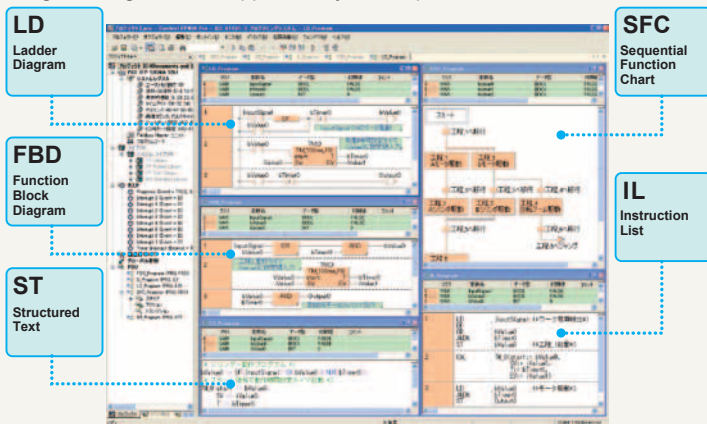
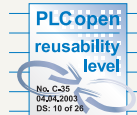

Features

- Five programming languages can be used.**
Programming can be done using the language most familiar to the developer or using the language most suited to the process to be performed. High-level (structured text) languages that allow structuring, such as C, are supported.
- Easy to reuse well-proven programs**
Efficiency when writing programs has been greatly increased by being able to split programming up for each function and process using structured programming.
- Keep know-how from getting out**
By "black boxing" a part of a program, you can prevent know-how from leaking out and improve the program's maintainability.
- Uploading of source programs from PLC possible.**
Maintainability increased by being able to load programs and comments from the PLC.
- Programming for all models in the FP series possible.**

Programming in the language most suited to the process

Easy-to-understand, efficient programs can be created, for example, by using a ladder program for machine control or ST for communications control.

Programming in the language you are good at

Programming time can be greatly reduced by the easy ability to split and then integrate programming for each function and process.

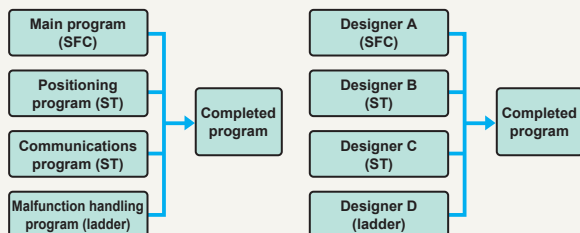

Operational Environment * FPO R is compatible with Ver. 6.1 or later.

| | |
|--------------------|---|
| OS | Windows 2000/XP/Vista/7 (Note) |
| Hard disk capacity | At least 120 MB |
| CPU | Pentium III processor (700 MHz) or compatible |
| Onboard memory | At least 256 MB RAM or more |
| Screen resolution | At least 1,024 x 768 |
| Display colors | High Color (16-bit) or higher |
| Applicable PLC | FP0R/FP0/FPΣ/FP-X/FP-e/FP2/FP2SH |

Note: Only Ver. 6.2 or later is compatible with Windows 7. (To be released in September 2011)

Control FPCWIN GR (Windows version software)

The ladder programming software for FP series Highly operational software tool for maximizing convenience in the field

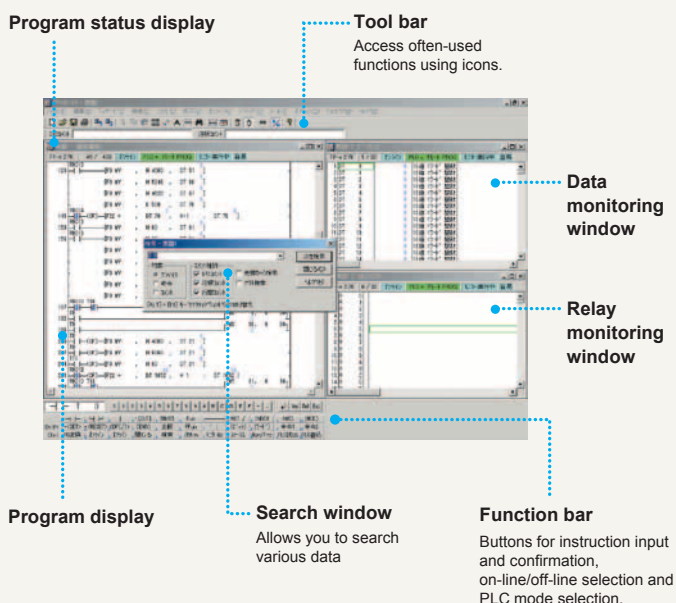

Features

- Easy field operations not requiring the use of a mouse for data entry, search, writing, monitoring and timer changes, all carried out only from the keyboard.**
- All FP series PLCs are supported.**
- Easy programming with wizard functions.**
- Communication with GTWIN and PCWAY simultaneously through the same port.**
- A simulation function is available.**









Operational Environment * FPO R is compatible with Ver. 2.8 or later.

| | |
|--------------------|--------------------------------------|
| OS | Windows 98/Me/2000/XP/Vista/7 (Note) |
| Hard disk capacity | At least 40 MB |
| CPU | Pentium 100 MHz or higher |
| Onboard memory | At least 64 MB (depends on OS) |
| Screen resolution | At least 1,024 x 768 |
| Display colors | High Color (16-bit) or higher |
| Applicable PLC | FP0R/FP0/FPΣ/FP-X/FP-e/FP2/FP2SH |











Note: Only Ver. 2.90 or later is compatible with Windows 7.

PART NUMBER LIST

Control units





| | | | |
|---|---|---|---|
| 10 points Input: 6, Relay output: 4 Terminal block type  AFP0RC10RS (with RS232C) AFP0RC10CRS (with RS485) AFP0RC10MRS | 10 points Input: 6, Relay output: 4 Connector type  AFP0RC10RM (with RS232C) AFP0RC10CRM | 14 points Input: 8, Relay output: 6 Terminal block type  AFP0RC14RS (with RS232C) AFP0RC14CRS (with RS485) AFP0RC14MRS | 14 points Input: 8, Relay output: 6 Connector type  AFP0RC14RM (with RS232C) AFP0RC14CRM |
| 16 points Input: 8, Transistor output: 8 MIL connector type  AFP0RC16T AFP0RC16P (with RS232C) AFP0RC16CT AFP0RC16CP (with RS485) AFP0RC16MT AFP0RC16MP | 32 points Input: 16, Transistor output: 16 MIL connector type  AFP0RC32T AFP0RC32P (with RS232C) AFP0RC32CT AFP0RC32CP (with RS485) AFP0RC32MT AFP0RC32MP | 32 points Input: 16, Transistor output: 16 MIL connector type T type  (with RS232C) AFP0RT32CT AFP0RT32CP (with RS485) AFP0RT32MT AFP0RT32MP | 32 points Input: 16, Transistor output: 16 MIL connector type F type  (with RS232C) AFP0RF32CT AFP0RF32CP (with RS485) AFP0RF32MT AFP0RF32MP |

Expansion units

| | | | | |
|--|---|---|---|--|
| 8 points Input: 8 MIL connector type  AFP0RE8X | 8 points Input: 4, Relay output: 4 Terminal block type Connector type   AFP0RE8RS AFP0RE8RM | 8 points Relay output: 8 Terminal block type  AFP0RE8YRS | 8 points Transistor output: 8 MIL connector type  AFP0RE8YT AFP0RE8YP | 32 points Input: 16, Transistor output: 16 MIL connector type  AFP0RE32T AFP0RE32P |
| 16 points Input: 16 MIL connector type  AFP0RE16X | 16 points Transistor output: 16 MIL connector type  AFP0RE16YT AFP0RE16YP | 16 points Input: 8, Transistor output: 8 MIL connector type  AFP0RE16T AFP0RE16P | 16 points Input: 8, Relay output: 8 Terminal block type Connector type   AFP0RE16RS AFP0RE16RM | |



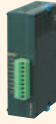

Intelligent units

Units in common with FP0

| | | | | |
|---|---|--|--|---|
| Analog I/O unit Input: 2 ch, Output: 1 ch Terminal block type  Part number: AFP0480 Product number: (FP0-A21) | A/D converter unit Input: 8 ch Terminal block type  AFP0401 (FP0-A80) | D/A converter unit Voltage output: 4 ch Terminal block type  AFP04121 (FP0-A04V) | D/A converter unit Current output: 4 ch Terminal block type  AFP04123 (FP0-A04I) | Thermocouple unit  (4 ch) AFP0420 (FP0-TC4) (8 ch) AFP0421 (FP0-TC8) |
|---|---|--|--|---|



Link and Communication units

Units in common with FP0

| | | | |
|--|--|---|--|
| I/O link unit  Part number: AFP0732 Product number: (FP0-IOL) | CC-Link slave unit  AFP07943 (FP0-CCLS) | KS1 Signal converter  AKS1202 | FP Web-server 2 Unit  AFP0611 (FP-WEB2) |
|--|--|---|--|

Power supply unit and others

Units in common with FP0

| | |
|--|---|
| Power supply unit Input: 100 to 240 V AC, Output: 24 V DC, 0.7 A  Part number: AFP0634 Product number: (FP0-PSA4) | FP memory loader  Data clear type: AFP8670 Data hold type: AFP8671 * FP0R is compatible with Ver. 2.0 or later. |
|--|---|

INSTALLATION AND OPTIONS

Installation

The control unit width is only 25 mm 0.98 in*. Even when expanded to allow for 128 I/O points, the total width is only 105 mm 4.13 in.

The control unit is pocket-sized: W 25 x H 90 x D 60 mm W 0.98 x H 3.54 x D 2.36 in.

The number of I/O points can be expanded up to 128. Even with the maximum expansion, the size is only W 105 x H 90 x D 60 mm W 4.13 x H 3.54 x D 2.36 in. The ultra-compact body size and installation area facilitate the miniaturization of target machines, equipment, and control panels.

* The 32 I/O points type control unit is 30 mm 1.18 in in width.

Three options for installation methods

The control unit can be directly mounted on a panel by using the optional flat type mounting plate.



DIN rail

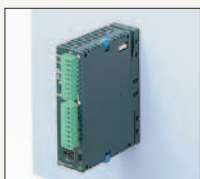

Slim type mounting plate

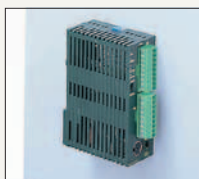

Flat type mounting plate*

* Cannot be used when expanded.

Up to three expansion units can be directly connected without connection cables.

The expansion units can be directly connected to the control unit with a simple operation using the expansion connector and lock lever on the side of the unit. Dedicated cables or backplanes are not necessary for expansion.

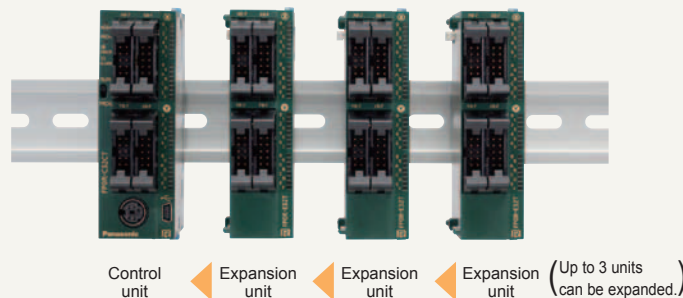

A terminal block type and a connector type are available. Both can be detached for easy wiring.

Options

Wiring tools



Terminal screwdriver

Necessary when wiring relay output type and terminals block (Phoenix).

Part number: **AFP0806**



Molex connector pressure contact tool

Necessary when wiring relay output type and molex connectors.

Part number: **AFP0805**



Multi-wire connector pressure contact tool

Necessary when wiring transistor output type connectors.

Part number: **AXY52000FP**

Parts for mounting



FP0 Slim type mounting plate

Screw-stop attachment plate, Slim model

Part number: **AFP0803** (including 10 pieces)



Flat type mounting plate

Screw-stop attachment plate, Flat model

Part number: **AFP0804** (including 10 pieces)

I/O cables



Relay output molex type I/O cable

Loose-wiring cable (9 leads) with molex socket attached at one end, AWG20, 0.5 mm², 1 set: 2 cables (blue & white)

< Length: 1 m 3.28 ft > 2 cable set < Length: 3 m 9.84 ft > 2 cable set
Part number: **AFP0551** Part number: **AFP0553**



Transistor output type I/O cable

Loose-wiring cable (10 leads) with connectors attached at one end, AWG22, 0.3 mm², 1 set: 2 cables (blue & white).

< Length: 1 m 3.28 ft > 2 cable set < Length: 3 m 9.84 ft > 2 cable set
Part number: **AFP0521** Part number: **AFP0523**

Flat cable connector set (10 leads)

Part number: **AFP0808** (including 4 pieces)

Notes: 1) One I/O cable set (2 cables) is necessary with the following models: C10RS / C10RM, C14RS / C14RM, E8RS / E8RM, E16RS / E16RM
2) One I/O cable set (2 cables) is necessary with the following models: C16T / E16X, E16T / E16YT
3) Two I/O cable sets (total 4 cables) are necessary with the following models: C32T / E32T

Maintenance parts



Terminal socket

Attaches to relay output and terminal block types.

Part number: **AFP0802** (2 sockets per pack)



Molex socket

Attaches to relay output and molex connector types.

Part number: **AFP0801** (2 sockets per pack)



Wire-press socket

Attaches to transistor output type.

Part number: **AFP0807** (2 sockets per pack)



FPOR Power cable (Length: 1 m 3.28 ft)

Attaches to FPOR control unit.

Part number: **AFP0805** (1 cable per pack)

OPTIONS

■ OPTIONS

● RT-3 unit relays (Power PhotoMOS relay type)



RT-3 unit relay

| Contact arrangement | Type | Rated input voltage | RT-3 Unit relay | | |
|---------------------|--|---------------------|-----------------|----------|--|
| | | | Product No. | Part No. | Packing quantity |
| 1 Form A × 4 | DC only (equipped with AQZ102) | 12 V DC | RT3SP1-12V | AY34001 | Inner carton: 1 piece Outer case: 20 pieces |
| | | 24 V DC | RT3SP1-24V | AY34002 | |
| | AC / DC dual use (equipped with AQZ204) | 12 V DC | RT3SP2-12V | AY35001 | |
| | | 24 V DC | RT3SP2-24V | AY35002 | |

Notes: 1) Only for use with Power PhotoMOS relays. Cannot be equipped with PA relays.
2) Please consult us other contact arrangement.

● RT-3 unit relays (PA relay type)



RT-3 unit relay

| Contact arrangement | Rated input voltage | RT-3 Unit relay | | |
|---------------------|---------------------|-----------------|----------|--|
| | | Product No. | Part No. | Packing quantity |
| 1 Form A × 4 | 12 V DC | RT3S-12V | AY33001 | Inner carton: 1 piece Outer case: 20 pieces |
| | 24 V DC | RT3S-24V | AY33002 | |

Notes: 1) Only for use with PA relay type. Cannot be equipped with Power PhotoMOS relay standard type. However, equipping with voltage sensitive type is possible.
2) 5 V DC type relays are also available. Please consult us.
3) Please consult us other contact arrangement.

● 4-point terminals

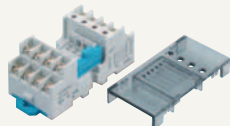

4-point terminals

| Type | Rated input voltage | Part No. |
|---|---------------------|----------|
| PA relay and Voltage sensitive type power PhotoMOS relay type | 12, 24 V DC | AY30000 |

Packing quantity: inner carton: 1 piece, outer case: 20 pieces

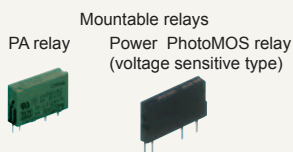

Mountable relays for 4-point terminal

| Product name | Part No. |
|---|----------------------------|
| PA relay | APA3311 and APA3312 |
| Power PhotoMOS relay (voltage sensitive type) | AQZ10*D (DC only) |
| | AQZ20*D (AC / DC dual use) |

Note: Never mount relays into this product other than those given above.
Doing so will cause malfunction, breakdown, and breakdown of the connected product.

● RT-2 relay terminals

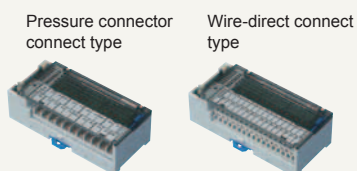

DIN rail mounting type

1. Pressure connector connect type

| I / O type | Rated voltage | Product No. | Part No. | Packing quantity |
|---------------|---------------|---------------|----------|--|
| Input device | 12 V DC | RT2S-ID16-12V | AY231501 | Inner carton: 1 piece Outer case: 10 pieces |
| | 24 V DC | RT2S-ID16-24V | AY231502 | |
| Output device | 12 V DC | RT2S-OD16-12V | AY232501 | |
| | 24 V DC | RT2S-OD16-24V | AY232502 | |

2. Wire-direct connect type

| I / O type | Rated voltage | Product No. | Part No. | Packing quantity |
|---------------|---------------|-----------------|----------|--|
| Input device | 12 V DC | RT2S-C-ID16-12V | AY231511 | Inner carton: 1 piece Outer case: 10 pieces |
| | 24 V DC | RT2S-C-ID16-24V | AY231512 | |
| Output device | 12 V DC | RT2S-C-OD16-12V | AY232511 | |
| | 24 V DC | RT2S-C-OD16-24V | AY232512 | |

■ OPTIONS

● Cables

Expansion cable with wire-pressed terminal



Expansion cable



M type 16-point, 34-pin output cable



Connecting cables for FP series and Interface terminal

| Product name | Controller side unit | No. of connector contacts of controller side | Interface terminal | Product name and shape | Connecting cable | | | | | | |
|--------------------|--------------------------|--|--|---|-------------------|--------------------|----------------------|----------------------|----------------------|-----------------------|-----------------------|
| | | | | | 250 mm 9.84 in | 500 mm 19.69 in | 1,000 mm 39.37 in | 1,500 mm 59.06 in | 2,000 mm 78.74 in | 3,000 mm 118.11 in | 5,000 mm 196.85 in |
| FP0 FP0R FPΣ | 8 points Input unit | Input side: 10-pin | RT-2 relay terminal RT-1 PC relay terminal | For FP0 and FP0R 8-point input | - | - | AY15013 | AY15014 | AY15015 | AY15016 | AY15017 |
| | 16 points Input unit | Input side: 10-pin × 2 | RT-2 relay terminal RT-1 PC relay terminal | For FP0, FP0R and FPΣ 16-point input | - | - | AY15913 | AY15914 | AY15915 | AY15916 | AY15917 |
| | 8 points Output unit | Output side: 10-pin | RT-2 relay terminal RT-1 PC relay terminal | For FP0 and FP0R 8-point output | - | - | AY15023 | AY15024 | AY15025 | AY15026 | AY15027 |
| | 16 points Output unit | Output side: 10-pin × 2 | RT-2 relay terminal RT-1 PC relay terminal | For FP0, FP0R and FPΣ 16-point output | - | - | AY15923 | AY15924 | AY15925 | AY15926 | AY15927 |
| | 16 points I/O unit | I/O side: 20-pin | Connector terminal | 20P | - | AYT52202 | AYT52203 | AYT52204 | AYT52205 | AYT52206 | AYT52207 |
| | 64 points I/O unit | I/O side: 40-pin | RT-2 relay terminal RT-1 PC relay terminal / S type | For FPΣ 64-point I/O unit Controller side: 32 points, 16 points Terminal side: 20 points, 16 points | - | - | AY15633 | AY15634 | AY15635 | AY15636 | AY15637 |

(Standard packing; carton: 1 pc., Case: 10 pcs.)

Expansion cables with wire-pressed terminal for relay terminal

| Product name and shape | I/O type | Relay terminal | Length (Part number) | | | | |
|---|--------------------------------|--|----------------------|----------------------|----------------------|-----------------------|-----------------------|
| | | | 1,000 mm 39.37 in | 1,500 mm 59.06 in | 2,000 mm 78.74 in | 3,000 mm 118.11 in | 5,000 mm 196.85 in |
| Expansion cable with wire-pressed terminal Relay terminal side | 16-point both input and output | RT-2 relay terminal RT-1 PC relay terminal / S type | AY15853 | AY15854 | AY15855 | AY15856 | AY15857 |

Note: Please consult us regarding connecting cables for the various controllers. Regarding the expansion cables with wire-pressed terminal, the triangle mark does not correspond to wire No. 1, so be sure to inquire for details.

● WAGO DIO Station

For Easy and Secure Connection Between FP0R and a Sensor

Power supply unit → **FP0R**

(1) Common terminal block: 24 V DC can be branched. Power is supplied through the cable to the PLC common terminal and the sensor. The cable comes in lengths up to 10 m (32.81 ft) in increments of 0.1 m (0.33 ft).

(2) Cable for input: (2) Cable for input

(3) Cable for output: (3) Cable for output

(4) DIO station: Quick connection with DIO using the finger lever. The connector can be reused. Example: Sensor (Even a thin sensor or electrical wire can be connected. (0.08 - 0.5 sq)). Example: Switch and Lamp.

(2)(3) Cable specifications
 AWG28, Rated voltage: 30 V
 Outer diameter of sheath: $\varnothing 4.4 \varnothing 0.17$
 Minimum allowable bending radius: $R = 13.2$
 Power supply wire: 0.3 sq, 250 mm 9.84 in

| Product name | Product number | Ident number |
|----------------------------------|--------------------|--------------|
| (1) Common terminal block | PM-PW8-739/3.5 | 51197832 |
| (2) PM flexible cable for input | PM-FP0X-M733SS-F1M | 51251907 |
| (3) PM flexible cable for output | PM-FP0Y-M733SS-F1M | 51251909 |
| (4) 8 points, MIL-DIO station | PM-M733-3X8PC-S1 | 51238076 |

Contact WAGO Kontakttechnik GmbH & Co. KG for inquiries about DIO Station.
 URL: <http://www.wago.com>

COMPATIBILITY

Compatibility between FP0 and FP0R

Programs

FP0R has an "FP0-compatible mode". This mode provides conditions for functions, memory areas, system registers, etc. identical to those of FP0. If programs in FP0 are transported to FP0R, FP0R can function identically as FP0 did (with some exceptions described below).

Installation

The shape, outside dimensions, installation method, and the connector pin arrangement are identical to those of FP0.

This high degree of compatibility ensures easy and worry-free replacement of FP0 with FP0R even if the device or machine to be manufactured is identical.

- It is recommended that Control **FPWIN Pro** or **FPWIN GR** should be used for transporting FP0 programs to FP0R. Before an FP0 program is downloaded to FP0R, a message stating "Switch to FP0-compatible mode for the download?" appears. If "Yes" is chosen, FP0R will automatically be set in FP0-compatible mode.

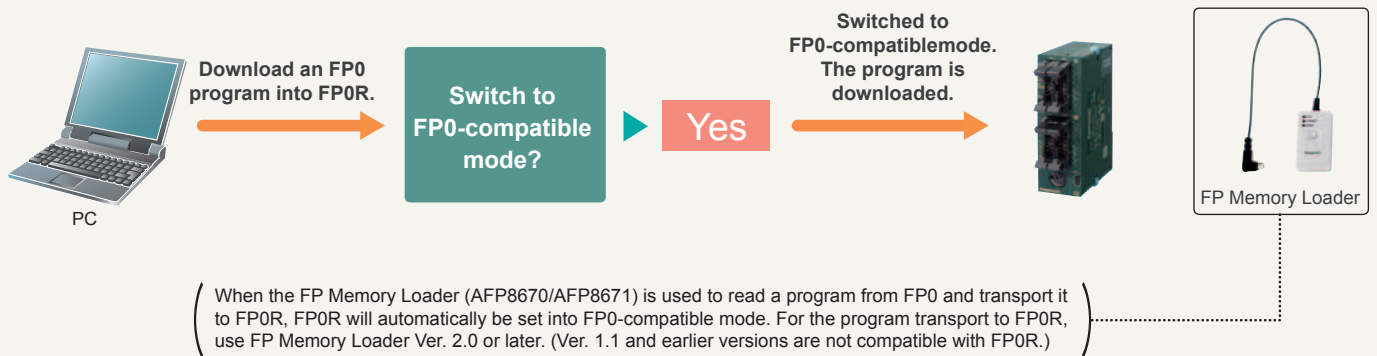

- FP0 specification items not covered by FP0-compatible mode** (See "FP0R User's Manual" for details.)

| Item | FP0 | FP0R (FP0-compatible mode) |
|---|--|---|
| Instruction P13: EEPROM write time | 5 ms / block (256 blocks max.: 1,280 ms) | 100 ms in units of 32 blocks (256 blocks max.: 800 ms) * Writing even only one block takes 100 ms. |
| Instruction F170: PWM output frequency range | 0.15 Hz to 1 kHz | 6 Hz to 1 kHz |
| High-speed counter/pulse output elapsed value | ± 24 bits | ± 32 bits |
| Instruction F168: Home return | The elapsed value is not counted during home return. | The elapsed value is counted during home return. |
| Instruction F169: Pulse output | "Non-counting mode" selectable | Counted and added even when "non-counting mode" is selected |
| Instruction F144: Serial data communications | Transmittable data size: Unlimited | Transmittable data size: 2,048 |

Note: The F type has no compatible functions because it does not correspond to any units of the conventional FP0 series.

■ Control unit replacement table

FP0
➔ FP0R

| Product name | Product No. | Part No. | | Product name | Part No. |
|--|-------------|-----------|---|--|--------------------------|
| FP0-C10 Control unit | FP0-C10RS | AFP02123 | Order receiving will be discontinued in August 2012. | FP0R-C10 Control unit | AFP0RC10RS |
| | FP0-C10RM | AFP02113 | | | AFP0RC10RM |
| FP0-C10 Control unit with RS232C port | FP0-C10CRS | AFP02123C | | FP0R-C10 Control unit with RS232C port | AFP0RC10CRS |
| | FP0-C10CRM | AFP02113C | | | AFP0RC10CRM |
| FP0-C14 Control unit | FP0-C14RS | AFP02223 | | FP0R-C14 Control unit | AFP0RC14RS |
| | FP0-C14RM | AFP02213 | | | AFP0RC14RM |
| FP0-C14 Control unit with RS232C port | FP0-C14CRS | AFP02223C | | FP0R-C14 Control unit with RS232C port | AFP0RC14CRS |
| | FP0-C14CRM | AFP02213C | | | AFP0RC14CRM |
| FP0-C16 Control unit | FP0-C16T | AFP02343 | | FP0R-C16 Control unit | AFP0RC16T |
| | FP0-C16P | AFP02353 | | | AFP0RC16P |
| FP0-C16 Control unit with RS232C port | FP0-C16CT | AFP02343C | | FP0R-C16 Control unit with RS232C port | AFP0RC16CT |
| | FP0-C16CP | AFP02353C | | | AFP0RC16CP |
| FP0-C32 Control unit | FP0-C32T | AFP02543 | | FP0R-C32 Control unit | AFP0RC32T |
| | FP0-C32P | AFP02553 | | | AFP0RC32P |
| FP0-C32 Control unit with RS232C port | FP0-C32CT | AFP02543C | FP0R-C32 Control unit with RS232C port | AFP0RC32CT | |
| | FP0-C32CP | AFP02553C | | AFP0RC32CP | |
| FP0-T32 Control unit with RS232C port, clock / calendar function and 10 k type | FP0-T32CT | AFP02643C | FP0R-T32 Control unit with RS232C port and real clock / calendar function | AFP0RT32CT | |
| | FP0-T32CP | AFP02653C | | AFP0RT32CP | |
| FP0-S-LINK Control unit with RS232C port | FP0-SL1 | AFP02700 | Continue to be available | | |
| No corresponding models | | | | FP0R-F32 Control unit with RS232C port | AFP0RF32CT AFP0RF32CP |

■ Expansion unit replacement table

FP0
➔ FP0R

| Product name | Product No. | Part No. | | Product name | Part No. |
|--------------|-------------|----------|--|--------------|------------|
| FP0-E8 | FP0-E8X | AFP03003 | Order receiving will be discontinued in August 2012. | FP0R-E8 | AFP0RE8X |
| | FP0-E8RS | AFP03023 | | | AFP0RE8RS |
| | FP0-E8RM | AFP03013 | | | AFP0RE8RM |
| | FP0-E8YRS | AFP03020 | | | AFP0RE8YRS |
| | FP0-E8YT | AFP03040 | | | AFP0RE8YT |
| | FP0-E8YP | AFP03050 | | | AFP0RE8YP |
| FP0-E16 | FP0-E16X | AFP03303 | | FP0R-E16 | AFP0RE16X |
| | FP0-E16RS | AFP03323 | | | AFP0RE16RS |
| | FP0-E16RM | AFP03313 | | | AFP0RE16RM |
| | FP0-E16T | AFP03343 | | | AFP0RE16T |
| | FP0-E16P | AFP03353 | | | AFP0RE16P |
| | FP0-E16YT | AFP03340 | | | AFP0RE16YT |
| | FP0-E16YP | AFP03350 | AFP0RE16YP | | |
| FP0-E32 | FP0-E32T | AFP03543 | FP0R-E32 | AFP0RE32T | |
| | FP0-E32P | AFP03553 | | AFP0RE32P | |

SPECIFICATIONS

Performance specifications (FP0R Control units)

| Product type of FP0R control unit | | C10 (Relay output type only) | C14 (Relay output type only) | C16 (Transistor output type only) | C32 (Transistor output type only) | T32 (Transistor output type only) | F32 (Transistor output type only) |
|-------------------------------------|--|---|---|---|---|---|---|
| Programming method / Control method | | Relay symbol / Cyclic operation | | | | | |
| Number of I/O points | No expansion (Control unit only) | 10 points [Input: 6, Relay output: 4] | 14 points [Input: 8, Relay output: 6] | 16 points [Input: 8, Transistor output: 8] | 32 points [Input: 16, Transistor output: 16] | 32 points [Input: 16, Transistor output: 16] | |
| | With expansion 1 * Same type of control and expansion units | Max. 58 points | Max. 62 points | Max. 112 points | Max. 128 points | Max. 128 points | |
| | With expansion 2 * Mix type of relay and transistor units | Max. 106 points | Max. 110 points | Max. 112 points | Max. 128 points | Max. 128 points | |
| Program memory | | EEPROM (no backup battery required) | | | | | |
| Program capacity | | 16 k steps | | | 32 k steps | | |
| Number of instructions | Basic | 110 approx. | | | | | |
| | High-level | 210 approx. | | | | | |
| Operation speed | Up to 3,000 steps | Basic instructions: 0.08 µs Min. Timer instructions: 2.2 µs Min. High-level instructions: 0.32 µs (MV instruction) Min. | | | | | |
| | 3,001st and later steps | Basic instructions: 0.58 µs Min. Timer instructions: 3.66 µs Min. High-level instructions: 1.62 µs (MV instruction) Min. | | | | | |
| Operation memory | Relay | Internal relay (R) | 4,096 points | | | | |
| | | Timer / Counter (T / C) | 1,024 points | | | | |
| | Memory area | Data register (DT) | 12,315 words | | | 32,765 words | |
| Index register (IX, IY) | | 14 words (IO to ID) | | | | | |
| Master control relay points (MCR) | | 256 words | | | | | |
| Number of labels (JMP and LOOP) | | 256 labels | | | | | |
| Differential points | | Equivalent to the program capacity | | | | | |
| Number of step ladder | | 1,000 stages | | | | | |
| Number of subroutines | | 500 subroutines | | | | | |
| Special functions | High speed counter | Single-phase: 6 points (50 kHz max. each) 2-phase: 3 channels (15 kHz max. each)* | | | | | |
| | Pulse output | Not available | | 4 points (50 kHz max. each) Two channels can be controlled individually.* | | | |
| | PWM output | Not available | | 4 points (6 Hz to 4.8 kHz) | | | |
| | Pulse catch input / interrupt input | Total 8 points (with high speed counter) | | | | | |
| | Interrupt program | Input: 8 programs (6 programs for C10 only) / Periodic: 1 program / Pulse match: 4 programs | | | | | |
| | Periodical interrupt | In units of 0.5 ms: 0.5 ms to 1.5 sec. / In units of 10 ms: 10 ms to 30 sec. | | | | | |
| | Constant scan | In units of 0.5 ms: 0.5 ms to 600 ms | | | | | |
| Maintenance | RS232C port | One RS232C port is mounted on each of C10CRS, C10CRM, C14CRS, C14CRM, C16CT, C16CP, C32CT, C32CP, T32CT, T32CP, F32CT and F32CP type (3P terminal block) Transmission speed (Baud rate): 2,400 to 115,200 bits/s, Transmission distance: 15 m 9.8 ft. Communication method: half duplex | | | | | |
| | RS485 port | One RS485 port is mounted on each of C10MRS, C14MRS, C16MT, C16MP, C32MT, C32MP, T32MT, T32MP, F32MT and F32MP type(3P terminal block) Transmission speed (Baud rate): 115.2 kbps (It is possible to change to 19.2 kbps by the setting.), Transmission distance: 1,200 m 3,937 ft. Communication method: half duplex | | | | | |
| Maintenance | Memory backup | Program and system register | Stored program and system register in EEPROM | | | Backup of the entire area by a built-in secondary battery | Backup of the entire area by FeRAM (without the need for a battery) |
| | | Operation memory | Stored fixed area in EEPROM Counter: 16 points Internal relay: 128 points Data register: 315 words | | | | |
| | Self-diagnostic function | Watchdog timer (690 ms approx.), Program syntax check | | | | | |
| | Real-time clock function | Not available | | | | Available | Not available |
| Other functions | | Rewriting in RUN mode, Download in RUN mode (incl. comments), 8-character password setting, and Program upload protection | | | | | |

* For the limitations while operating units, see the manual.

General specifications (FP0R Control units)

| Item | Specifications |
|--|--|
| Rated voltage | 24 V DC |
| Operating voltage range | 20.4 to 28.8 V DC |
| Allowed momentary power off time | C10, C14, C16 5 ms (at 20.4 V DC), 10 ms (21.6 V DC or higher) |
| | C32, T32, F32 10 ms (20.4 V DC or higher) |
| Ambient temperature | 0 to +55 °C 32 to +131 °F |
| Storage temperature | -40 to +70 °C -40 to +158 °F (-20 °C to +70 °C -4 to +158 °F for T32 only) |
| Ambient humidity | 10 to 95% RH (at 25 °C 77 °F, no condensation) |
| Storage humidity | 10 to 95% RH (at 25 °C 77 °F, no condensation) |
| Breakdown voltage (Detection current: 5 mA) | Input terminals - output terminals, Output terminals - power and functional ground terminals --- Transistor output: 500 V AC for 1 minute (Relay output: 1,500 V AC for 1 minute) / Input terminals - power and functional ground terminals, Functional ground terminal - power terminal --- Transistor output: 500 V AC for 1 minute (Relay output: 500 V AC for 1 minute) / Output terminals - output terminals (different common terminals) --- Relay output: 1,500 V AC for 1 minute |
| Insulation resistance (Test voltage: 500 V DC) | Input terminals - output terminals, input terminals - power and functional ground terminals, output terminals - power and functional ground terminals, functional ground terminal - power terminal --- Transistor output: 100 MΩ minimum (relay output: 100 MΩ minimum) / Output terminals - output terminals (different common terminals) --- Relay output: 100 MΩ minimum |
| Vibration resistance | 5 to 9 Hz, single amplitude of 3.5 mm, 1 sweep/min; 9 to 150 Hz, constant acceleration of 9.8 m/s ² , 1 sweep/min; for 10 min each in X, Y, and Z directions |
| Shock resistance | 147 m/s ² or more, 4 times each in X, Y, and Z directions |
| Noise immunity | 1,000 V (p-p) with pulse widths 50 ns and 1 µs (using a noise simulator) (Power supply terminal) |
| Operating condition | Free from corrosive gasses and excessive dust |

Input specifications (Common to control units and expansion units) (As for the limitation on the number of simultaneous ON points, please refer to the manual.)

| Item | Specifications | |
|------------------------------|---|---|
| | Control unit | Expansion unit |
| Rated input voltage | 24 V DC | |
| Operating voltage range | 21.6 to 26.4 V DC | |
| Rated input current | 2.6 mA approx. (at 24 V DC) | 4.7 mA approx. (at 24 V DC) |
| Input impedance | 9.1 kΩ approx. | 5.1 kΩ approx. |
| Input points per common | 6 points / common (C10), 8 points / common (C14, C16), 16 points / common (C32, T32, F32) | |
| Min. ON voltage/ON current | 19.2 V / 2 mA | |
| Max. OFF voltage/OFF current | 2.4 V / 1.2 mA | |
| Response time | OFF → ON | 20 µs or less * An input time constant (0.1 to 64 ms) can be set. |
| | ON → OFF | Same as above |
| Insulation method | Photocoupler | |

* Since the response time of X0 to X7 is very fast (for high-speed counter input) the FP0 happens to chattering noise as an input signal. To prevent this, it is recommended that the timer should be put in the ladder program.

SPECIFICATIONS

Output specifications (Common to control units and expansion units)

1. Relay output type

(As for the limitation on the number of simultaneous ON points, please refer to the manual.)

| Item | Specifications |
|--------------------------|---|
| Output type | 1a |
| Rated control capacity | 2 A 250 V AC, 2 A 30 V DC (4.5 A / common) |
| Response time | OFF → ON: 10 ms approx. ON → OFF: 8 ms approx. |
| Life time | Mechanical: 2 x 10 ⁷ operations or more |
| | Electrical: 10 ⁵ operations or more |
| Surge absorber | None |
| Output points per common | 2 points / common + 1 point / common + 1 point / comon (C10), 4 points / common + 1 point / common + 1 point / comon (C14) |

2. Transistor output type

| Item | Specifications | |
|------------------------------|---|---|
| | NPN | PNP |
| Output type | Open collector | |
| Rated load voltage | 5 to 24 V DC | 24 V DC |
| Load voltage allowable range | 4.75 to 26.4 V DC | 21.6 to 26.4 V DC |
| Max. load current | C16, C32, T32 and F32: 0.2 A / point (Max. 14 per common terminal) E16, E32, E8Y and E16Y: 0.3 A / point (Max. 14 per common terminal) | |
| OFF state leakage current | 1 μA or less | |
| ON state voltage drop | 0.2 V DC or less | |
| Response time | OFF → ON | 20 μs or less (Load current: 5 mA or more), 0.1 ms or less (Load current: 0.5 mA or more) (Note) |
| | ON → OFF | 40 μs or less (Load current: 5 mA or more), 0.2 ms or less (Load current: 0.5 mA or more) (Note) |
| External power supply | Voltage | 21.6 to 26.4 V DC |
| | Current | C16, E16T and E8YT: 30 mA or less C32, T32, F32, E32T and E16Y: 60 mA or less C16, E16P and E8YP: 35 mA or less C32, T32, F32, E32P and E16YP: 70 mA or less |
| Surge absorber | Zener diode | |
| Output points per common | 8 points / common (C16T), 16 points / common (C32, T32, F32) | |
| Insulation method | Photocoupler | |

Note: For expansion unit: 1 ms or less

I/O circuit diagrams

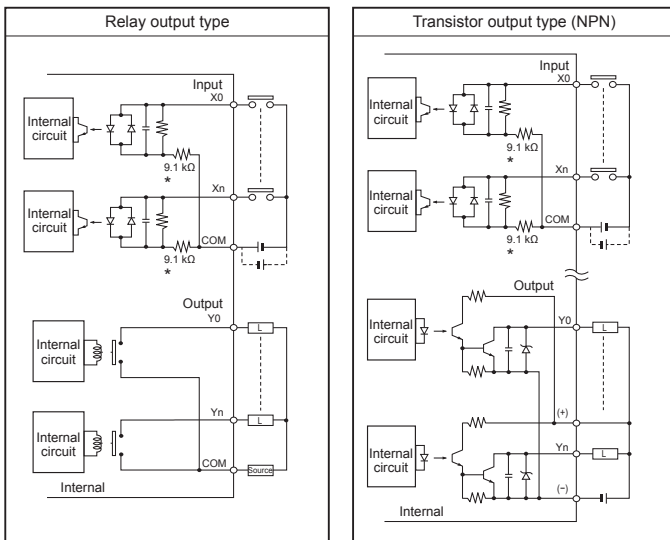

Note: For transistor output types, make sure that the externally supplied voltage between the (+) and (-) terminal is between 21.6 and 26.4 V DC.
* For expansion unit: 5.1 k Ω

Analog unit specifications (FP0 Expansion units)

1. Analog input specifications

| Item | Specifications | |
|------------------------------|---|--|
| | FP0-A21 | FP0-A80 |
| Number of input points | 2 channels / unit | 8 channels / unit (Number of input points can be changed 2, 4, 6 and 8 channels.) |
| Input range | Voltage range | 0 to 5 V (K0 to K4000) (Note 1) -10 to +10 V (K-2000 to K+2000) (Note 1) |
| | Current range | 0 to 20 mA (K0 to K4000) (Note 1) |
| Resolution | 1/4,000 (12 bits) | |
| Conversion speed | 1 ms / channel (Note 2) | |
| Overall precision | ±1 % F.S. or less (0 to 55 °C 32 to 131 °F), ±0.6 % F.S. or less (25 °C 77 °F) | |
| Input impedance | Voltage range | 1 MΩ or more |
| | Current range | 250 Ω |
| Absolute maximum input | Voltage range | ±15 V |
| | Current range | ±30 mA |
| Insulation method | Between analog input terminal and FP0 internal circuit: optical coupler insulation (non-insulated between channels) | Between analog output terminal and FP0 internal circuit: optical coupler insulation (non-insulated between channels) |
| | Between analog input terminal and analog I/O unit external power supply: based on insulation type DC/DC converter | Between analog input terminal and A/D converter unit external power supply: based on insulation-type DC/DC converter |
| Number of I/O contact points | 32 input contact points | |
| Averaging function | None | Can be switched on and off. |

Notes: 1) If the analog input value exceeds the upper or lower limit, the digital value will preserve the upper or lower limit.
2) The time shown below is required before the analog data is reflected in the control unit input.

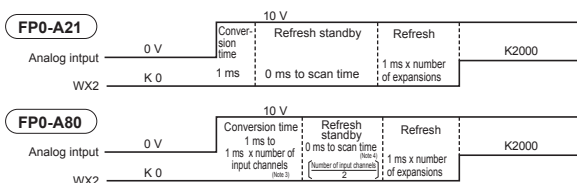

3) Settings value switch for the number of input channel
4) With each one scan of the control unit, the data for two channels will be loaded into control unit. In other words, if the input channel number switch is set to 8-channel, the data in the control unit will be updated once every four scans.

2. Analog output specifications

| Item | Specifications | | |
|---------------------------------|--|--|---|
| | FP0-A21 | FP0-A04V | FP0-A04I |
| Number of output points | 1 channel / unit | Voltage output 4 channels / units | Current output 4 channels / units |
| Output range | Voltage range | -10 to +10 V range (K-2000 to K+2000) (Note 1) | — |
| | Current range | 0 to 20 mA (K0 to K4000) (Note 1) | 4 to 20 mA (K0 to K4000) (Note 1) |
| Resolution | 1/4,000 (12 bits) | | |
| Conversion speed | 500 μs / channel (Note 2) | | |
| Overall precision | ±1 % F.S. or less (0 to 55 °C 32 to 131 °F), ±0.6 % F.S. or less (25 °C 77 °F) | | |
| Output impedance | Voltage range | 0.5 Ω or less | |
| | Current range | ±10 mA | |
| Absolute output load resistance | Voltage range | — | |
| | Current range | 30 Ω or less | 1,000 Ω or less |
| Insulation method (Note 2) | Between analog output terminal and FP0 internal circuit: optical coupler insulation (non-insulated between channels) | Between analog output terminal and analog I/O unit external power supply: based on insulation type DC/DC converter | Between analog output terminal and D/A converter unit external power supply: based on insulation type DC/DC converter |
| | Between analog output terminal and analog input terminal: based on insulation type DC/DC converter | | |
| Number of I/O contact points | 16 output contact points | 16 input contact points, 32 output contact points (Note 3) | |

Notes: 1) If the digital value exceeds the upper or lower limit, D/A conversion will not take place. (Analog output will remain as the previous data.)
2) The time shown below is required to update the actual analog output.

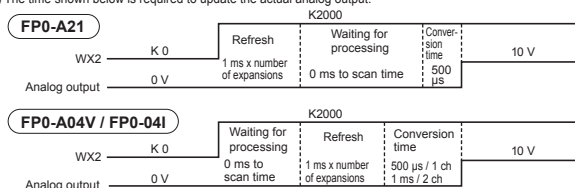

3) The data for two channels will be output to the D/A converter unit with one scan of the control unit.

Thermocouple unit specifications (FP0 Expansion units)

| Item | Specifications |
|------------------------|---|
| Number of input points | 4-channel, 8-channel (The number of input points can be changed 2, 4, 6 and 8 channels.) |
| Input range | Range for K and J: -100.0 to 500.0 °C / -148.0 to 790.0 °F (Note 1) |
| | Range for T: -100.0 to 400.0 °C / -148.0 to 752.0 °F |
| | Range for R: 0 to 1500.0 °C / 32.0 to 1590.0 °F (Note 1) |
| Digital output | K and J (when using °C): K-1000 to K5000 K and J (when using °F): K-1480 to K7900 (Note 1) (When range over using °C: K-1001, K5001 or K8000) (When range over using °F: K-1481, K7901 or K8000) (When the thermocouple broken: K8000) (Note 2) (Until the temperature can be measured at the initial startup: K8001) (Note 3) |
| | T (when using °C): K-1000 to K4000 T (when using °F): K-1480 to K7520 (When range over using °C: K-1001, K4001 or K8000) (When range over using °F: K-1481, K7521 or K8000) (When the thermocouple broken: K8000) (Note 2) (Until the temperature can be measured at the initial startup: K8001) (Note 3) |
| | R (when using °C): K0 to K15000 R (when using °F): K320 to K15900 (Note 1) (When range over using °C: K0, K15001 or K16000) (When range over using °F: K0, K15901 or K16000) (When the thermocouple broken: K16000) (Note 2) (Until the temperature can be measured at the initial startup: K16001) (Note 3) |
| | |
| | |
| | |

| Item | Specifications |
|------------------------------|---|
| Resolution | 0.1 °C |
| Sampling cycle (Note 5) | 300 ms: when using 2 channels for an input points (Note 4) 500 ms: when using 4 channels for an input points (Note 4) |
| | 700 ms: when using 6 channels for an input points (Note 4) 900 ms: when using 8 channels for an input points (Note 4) |
| Overall accuracy | Range for K and J: (-100 to 500 °C): ±0.8 °C or less (-100 to 400 °C): ±0.8 °C or less Range for T: (0 to 99.9 °C): ±3 °C or less (100 to 299.9 °C): ±2.5 °C or less (300 to 1,500 °C): ±2 °C or less |
| Input impedance | 1 MΩ or more |
| Insulation method | • Between thermocouple input terminals and FP0 internal circuits: Photo-coupler insulation, DC/DC converter insulation • Between thermocouple input terminal channels: PhotoMOS relay insulation |
| Number of I/O contact points | 32 input contact points (Note 6) |

Notes:
1) The measurement range available for degree Celsius is not available for degree Fahrenheit, of which the upper-limit measurement is set lower than degree Celsius, since the digital value (temperature value displayed) for degree Fahrenheit is bigger than that for degree Celsius.
2) When the thermocouple is broken, the digital value will become K8000 or K16000 within 70 seconds since broken. Practice in the ladder program a process for avoiding a risk, would be resulting from a broken thermocouple, and exchange the thermocouple.
3) Until the conversion data will be ready after the initial startup was made, the digital value shows K8001 or K16001. Those are not a temperature data. Create a ladder program, so that they are not acquired as a temperature data.
4) The settings of the input channel selection switch.
5) Conversion values for 6-time measurements (6 from the latest 8 measurements, excluding the max. and min.) are averaged, so that it takes time for the digital value to be displayed due to the rapid temperature change.
6) The control unit reads the data for 2 channels per 1 scan by the control unit. Read data by utilizing the sample program given in the product specifications and manual.

SPECIFICATIONS

I/O Link unit specifications (FP0 Expansion units)

| Item | Specifications |
|---|--|
| Communication method | Two-wire, half duplex |
| Synchronous method | Asynchronous method |
| Transmission line | 2-wire cable (Twisted-pair cable or VCTF 0.75 mm ² x 2C equivalent) |
| Transmission distance (Total distance) | Max. 700 m 2,297 ft (using twisted-pair cable) Max. 400 m 1,312 ft (using VCTF cable) |
| Transmission speed (Baud rate) | 0.5 Mbits/s |
| Number of control I/O point per an I/O link unit | 64 points (Input: 32 points and Output: 32 points) ^(Note) |
| Remote I/O map allocation | 32X / 32Y |
| Interface | Conforming to RS485 |
| Transmission error check | CRC (Cyclic Redundancy Check) method |

Note: This point number is the number of points that can be linked for inputting and outputting via the host PLC and network MEWNET-F. If the output for the I/O link unit error flag is set to ON, this number becomes 63 points (31 input points and 32 output points).

FP Web-server2 unit specifications (FP0 Expansion units)

| Item | Specifications |
|-------------------------|--|
| Communication functions | RS232C ↔ Ethernet conversion (PLC remote programming via Ethernet) E-mail sending function HTTP server function General-purpose communication (Server/Client) PPP server function |
| Communication interface | RS232C terminal block 3-pin: Mainly used for PLC connection RS232C D-Sub 9-pin: Mainly used for Modem connection 100 BASE-TX (RJ45): Used for Ethernet connection |
| RS232C communication | Transmission speed: 1,200, 2,400, 4,800, 9,600, 19,200, 38,400, 57,600, 115,200 bits/s Data length: 7 bits / 8 bits, Parity: Even / Odd / None |
| Ethernet communication | 100 Mbits/s (100 BASE-TX: RJ45) |
| Supported protocol | TCP, UDP, IP, DHCP, FTP, TELNET, HTTP, SMTP, and PPP |
| Memory size | 148 kB approx. (for storing htm files) |
| Setup method | Setup using FP Web Configurator Tool 2 |

CC-Link slave unit specifications (FP0 Expansion units)

1. Communication specifications

| Item | Specifications | | |
|--------------------------------------|--|-------------------------|-----------------------|
| Version | CC-Link Ver.1.10 | | |
| Communication method | Broadcast polling method | | |
| Transmission speed | 10 Mbits/s, 5 Mbits/s, 2.5 Mbits/s, 625 kbits/s, 156 kbits/s | | |
| Max. transmission distance (Note) | Ver. 1.10 CC-Link cable | CC-Link cable | |
| | 10 Mbits/s | 100 m 328 ft | 100 m 328 ft |
| | 5 Mbits/s | 160 m 525 ft | 150 m 492 ft |
| | 2.5 Mbits/s | 400 m 1,312 ft | 200 m 656 ft |
| | 625 kbits/s | 900 m 2,952 ft | 600 m 1,969 ft |
| 156 kbits/s | 1,200 m 3,937 ft | 1,200 m 3,937 ft | |
| Interface | RS485 | | |
| Station type | Remote device station | | |
| Number of occupied stations | 1 station | | |

Note: Length of the multi-drop connected cables at both ends
The cable length has restrictions in communication speed, CC-Link version, and dedicated cables to be used.
For details concerning the CC-Link, refer to the CC-Link Partner Association.
When an FP0 thermocouple unit is used with an FP0 CC-Link slave unit, the measurement accuracy of the thermocouple unit which is installed on the left of the CC-Link slave unit is as shown in the table below.

| Thermocouple | | Standard specifications | When CC-Link slave unit with a thermocouple unit |
|--------------|---|-------------------------|--|
| K, J and T | | 0.8 °C 33.44 °F | 2 °C 35.6 °F |
| R | 0 to 99.9 °C 32 to 211.82 °F | 3 °C 37.4 °F | 6 °C 42.8 °F |
| | 100 to 299.9 °C 212 to 571.82 °F | 2.5 °C 36.5 °F | 5 °C 41 °F |
| | 300 to 1,500 °C 572 to 2,732 °F | 2 °C 35.6 °F | 4 °C 39.2 °F |

Power supply unit specifications (FP0 Expansion units)

| Item | Specifications | |
|----------------------|------------------------------------|--|
| Input | Rated input voltage | 100 to 240 V AC |
| | Variable input voltage range | 85 to 264 V AC |
| | Rated frequency | 50/60 Hz |
| | Frequency range | 47 to 63 Hz |
| | Number of phases | Single-phase |
| | Inrush current | 30 A (0 to P) or less, with cold start |
| | Leakage current | 0.75 mA or less |
| | Allowable momentary power off time | 10 ms or more |
| Output | Rated voltage | 24 V DC |
| | Voltage accuracy | ±5 % |
| | Rated current | 0.7 A ^(Note) |
| | Output current range | 0 to 0.6 A |
| Protective functions | Ripple voltage | 500 mV or less |
| | Over-current protection | 0.63 A or more |
| | Over-voltage protection | Available |

Note: Start up may not be possible if a device with a large inrush current is connected even if below the rated current. In such a case, we recommend suppressing the inrush current by inserting a 1 to 2 Ω resistor between the power supply unit and the device.

Applicable crimp terminals

| Manufacturer | Part number | Applicable wiring |
|--------------------|-----------------------|--|
| JST Mfg. Co., Ltd. | V1.25-M3 (round type) | 0.35 to 1.65 mm ² AWG #22 to #15 |
| | V1.25-S3A (fork type) | |
| | V2-M3 (round type) | 1.04 to 2.00 mm ² AWG #17 to #14 |
| | V2-S3A (fork type) | |

7.2 mm **0.28 in** or less

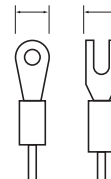

Current consumption

| Type of unit | Control unit current consumption (24 V DC) | Expansion unit current consumption (24 V DC) | |
|----------------------|--|--|----------------|
| FP0R control units | C10 | 100 mA or less | |
| | C14 | 120 mA or less | |
| | C16 | 70 mA or less | |
| | C32 | — | |
| | T32 | 90 mA or less | |
| | F32 | — | |
| FP0R expansion units | AFP0RE8X | 10 mA or less | |
| | AFP0RE8R | 10 mA or less | 50 mA or less |
| | AFP0RE8YR | 10 mA or less | 100 mA or less |
| | AFP0RE8YT/P | 15 mA or less | — |
| | AFP0RE16X | 10 mA or less | — |
| | AFP0RE16R | 20 mA or less | 100 mA or less |
| | AFP0RE16T/P | 20 mA or less | — |
| | AFP0RE16YT/P | 25 mA or less | — |
| | AFP0RE32T/P | 35 mA or less | — |

| Type of unit | Control unit current consumption (24 V DC) | Expansion unit current consumption (24 V DC) | |
|-----------------------|--|--|---|
| FP0 intelligent units | FP0-A21 | 20 mA or less | 100 mA or less |
| | FP0-A80 | 20 mA or less | 60 mA or less |
| | FP0-A04V | 20 mA or less | 100 mA or less |
| | FP0-A04I | 20 mA or less | 130 mA or less |
| | FP0-TC4 | 25 mA or less | — |
| | FP0-TC8 | — | — |
| Communication units | FP0-CCLS | 40 mA or less | 40 mA or less |
| | FP0-IOL | 30 mA or less | 40 mA or less |
| | FP-WEB2 | — | 95 mA or less (at 24 V DC) 240 mA or less (at 12 V DC) |
| | AFP15402 (C-NET adapter) | 50 mA or less | — |

Control unit current consumption

This refers to the current consumed via the power supply connector of the control unit. If expansion units or intelligent units are added, the current is increased by the value indicated above.

Expansion unit current consumption

This refers to the current consumed via the power supply connector of the expansion unit. Units with no value indication don't have a power supply connector.

PRODUCT TYPES

1 Control units

| Product name | Built-in memory (Program capacity) | Specifications | | | | | | Part number |
|--|---------------------------------------|----------------------|-------------------------|----------------------|-------------------------------------|-----------------------|-----------------|-------------|
| | | Number of I/O points | | Power supply voltage | Input | Output | Connection type | |
| FP0R-C10 Control Unit | EEPROM (16 k steps) | 10 | Input: 6 Output: 4 | 24 V DC | 24 V DC Sink/Source (±common) | Relay: 2 A | Terminal block | AFP0RC10RS |
| | | | | | | | Molex connector | AFP0RC10RM |
| FP0R-C10 Control Unit with RS232C port | EEPROM (16 k steps) | 10 | Input: 6 Output: 4 | 24 V DC | 24 V DC Sink/Source (±common) | Relay: 2 A | Terminal block | AFP0RC10CRS |
| | | | | | | | Molex connector | AFP0RC10CRM |
| FP0R-C10 Control Unit with RS485 port | EEPROM (16 k steps) | 10 | Input: 6 Output: 4 | 24 V DC | 24 V DC Sink/Source (±common) | Relay: 2 A | Terminal block | AFP0RC10MRS |
| FP0R-C14 Control Unit | EEPROM (16 k steps) | 14 | Input: 8 Output: 6 | 24 V DC | 24 V DC Sink/Source (±common) | Relay: 2 A | Terminal block | AFP0RC14RS |
| | | | | | | | Molex connector | AFP0RC14RM |
| FP0R-C14 Control Unit with RS232C port | EEPROM (16 k steps) | 14 | Input: 8 Output: 6 | 24 V DC | 24 V DC Sink/Source (±common) | Relay: 2 A | Terminal block | AFP0RC14CRS |
| | | | | | | | Molex connector | AFP0RC14CRM |
| FP0R-C14 Control Unit with RS485 port | EEPROM (16 k steps) | 14 | Input: 8 Output: 6 | 24 V DC | 24 V DC Sink/Source (±common) | Relay: 2 A | Terminal block | AFP0RC14MRS |
| FP0R-C16 Control Unit | EEPROM (16 k steps) | 16 | Input: 8 Output: 8 | 24 V DC | 24 V DC Sink/Source (±common) | Transistor NPN: 0.2 A | MIL connector | AFP0RC16T |
| | | | | | | Transistor PNP: 0.2 A | | AFP0RC16P |
| FP0R-C16 Control Unit with RS232C port | EEPROM (16 k steps) | 16 | Input: 8 Output: 8 | 24 V DC | 24 V DC Sink/Source (±common) | Transistor NPN: 0.2 A | MIL connector | AFP0RC16CT |
| | | | | | | Transistor PNP: 0.2 A | | AFP0RC16CP |
| FP0R-C16 Control Unit with RS485 port | EEPROM (16 k steps) | 16 | Input: 8 Output: 8 | 24 V DC | 24 V DC Sink/Source (±common) | Transistor NPN: 0.2 A | MIL connector | AFP0RC16MT |
| | | | | | | Transistor PNP: 0.2 A | | AFP0RC16MP |
| FP0R-C32 Control Unit | EEPROM (32 k steps) | 32 | Input: 16 Output: 16 | 24 V DC | 24 V DC Sink/Source (±common) | Transistor NPN: 0.2 A | MIL connector | AFP0RC32T |
| | | | | | | Transistor PNP: 0.2 A | | AFP0RC32P |
| FP0R-C32 Control Unit with RS232C port | EEPROM (32 k steps) | 32 | Input: 16 Output: 16 | 24 V DC | 24 V DC Sink/Source (±common) | Transistor NPN: 0.2 A | MIL connector | AFP0RC32CT |
| | | | | | | Transistor PNP: 0.2 A | | AFP0RC32CP |
| FP0R-C32 Control Unit with RS485 port | EEPROM (32 k steps) | 32 | Input: 16 Output: 16 | 24 V DC | 24 V DC Sink/Source (±common) | Transistor NPN: 0.2 A | MIL connector | AFP0RC32MT |
| | | | | | | Transistor PNP: 0.2 A | | AFP0RC32MP |
| FP0R-T32 Control Unit with RS232C port and Real-time clock function | EEPROM (32 k steps) | 32 | Input: 16 Output: 16 | 24 V DC | 24 V DC Sink/Source (±common) | Transistor NPN: 0.2 A | MIL connector | AFP0RT32CT |
| | | | | | | Transistor PNP: 0.2 A | | AFP0RT32CP |
| FP0R-T32 Control Unit with RS485 port and Real-time clock function | EEPROM (32 k steps) | 32 | Input: 16 Output: 16 | 24 V DC | 24 V DC Sink/Source (±common) | Transistor NPN: 0.2 A | MIL connector | AFP0RT32MT |
| | | | | | | Transistor PNP: 0.2 A | | AFP0RT32MP |
| FP0R-F32 Control Unit with RS232C port and Battery-less automatic all data backup function | EEPROM (32 k steps) | 32 | Input: 16 Output: 16 | 24 V DC | 24 V DC Sink/Source (±common) | Transistor NPN: 0.2 A | MIL connector | AFP0RF32CT |
| | | | | | | Transistor PNP: 0.2 A | | AFP0RF32CP |
| FP0R-F32 Control Unit with RS485 port and Battery-less automatic all data backup function | EEPROM (32 k steps) | 32 | Input: 16 Output: 16 | 24 V DC | 24 V DC Sink/Source (±common) | Transistor NPN: 0.2 A | MIL connector | AFP0RF32MT |
| | | | | | | Transistor PNP: 0.2 A | | AFP0RF32MP |

Notes: 1) See page 13 for the "Control unit replacement table" of the existing FP0 control units.
2) A power cable (Part number: AFPG805) is supplied with the control units.

2 Expansion units

| Product name | Specifications | | | | | | Part number | |
|-------------------------|----------------------|-------------------------|----------------------|-------------------------------------|-------------------------------------|-----------------------|----------------|------------|
| | Number of I/O points | | Power supply voltage | Input | Output | Connection type | | |
| FP0R-E8 Expansion Unit | 8 | Input: 8 | — | 24 V DC Sink/Source (±common) | — | MIL connector | AFP0RE8X | |
| | 8 | Input: 4 Output: 4 | 24 V DC | 24 V DC Sink/Source (±common) | Relay: 2 A | Terminal block | AFP0RE8RS | |
| | | | | | | Molex connector | AFP0RE8RM | |
| | 8 | Output: 8 | 24 V DC | — | — | Relay: 2 A | Terminal block | AFP0RE8YRS |
| | 8 | Output: 8 | — | — | — | Transistor NPN: 0.3 A | MIL connector | AFP0RE8YT |
| 8 | Output: 8 | — | — | — | Transistor PNP: 0.3 A | MIL connector | AFP0RE8YP | |
| FP0R-E16 Expansion Unit | 16 | Input: 16 | — | 24 V DC Sink/Source (±common) | — | MIL connector | AFP0RE16X | |
| | 16 | Input: 8 Output: 8 | 24 V DC | 24 V DC Sink/Source (±common) | Relay: 2 A | Terminal block | AFP0RE16RS | |
| | | | | | | Molex connector | AFP0RE16RM | |
| | 16 | Input: 8 Output: 8 | — | — | 24 V DC Sink/Source (±common) | Transistor NPN: 0.3 A | MIL connector | AFP0RE16T |
| | 16 | Input: 8 Output: 8 | — | — | 24 V DC Sink/Source (±common) | Transistor PNP: 0.3 A | MIL connector | AFP0RE16P |
| | 16 | Output: 16 | — | — | — | Transistor NPN: 0.3 A | MIL connector | AFP0RE16YT |
| 16 | Output: 16 | — | — | — | Transistor PNP: 0.3 A | MIL connector | AFP0RE16YP | |
| FP0R-E32 Expansion Unit | 32 | Input: 16 Output: 16 | — | 24 V DC Sink/Source (±common) | — | MIL connector | AFP0RE32T | |
| | 32 | Input: 16 Output: 16 | — | 24 V DC Sink/Source (±common) | Transistor PNP: 0.3 A | MIL connector | AFP0RE32P | |

Notes: 1) The relay output type expansion units come with a power cable (part number: AFP0581).
(The transistor output type expansion units need no power cable.)

2) The terminal block type relay output units have two terminal blocks (9 pins) made by Phoenix.

Use a 2.5 mm 0.10 inch wide screwdriver. Preferably use the specific terminal block screwdriver (part number: AFP0806, Phoenix type code SZSO, 4 x 2.5 mm 0.10 inch) or equivalent.

3) The connector type relay output units have two connectors made by Nihon Molex (Molex type code 51067-0900, 9 pins). Use the specific Molex connector press-fit tool (part number: AFP0805, Nihon Molex type code 57189-5000) or equivalent.

4) The transistor output units have a press-fit socket for wire-pressed terminal cable and contacts. Use the press-fit tool (part number: AXYS2000FP) for wire-pressed terminal cable.

PRODUCT TYPES

3 Intelligent units

| Product name | Specifications | Product number | Part number |
|------------------------|--|----------------|-------------|
| FP0 Analog I/O Unit | <Input specifications> Number or channels : 2 channels Input range : Voltage 0 to 5 V, -10 to +10 V (Resolution: 1/4,000) Current 0 to 20 mA (Resolution: 1/4,000) | FP0-A21 | AFP0480 |
| | <Output specifications> Number or channels : 1 channel Output range : Voltage -10 to +10 V (Resolution: 1/4,000) Current 0 to 20 mA (Resolution: 1/4,000) | | |
| FP0 A/D Converter Unit | <Input specifications> Number or channels : 8 channels Input range : Voltage 0 to 5 V, -10 to +10 V, -100 to 100 mV (Resolution: 1/4,000) Current 0 to 20 mA (Resolution: 1/4,000) | FP0-A80 | AFP0401 |
| FP0 D/A Converter Unit | <Output specifications> Number or channels : 4 channels Output range : (Voltage output type) -10 to +10 V (Resolution: 1/4,000) (Current output type) 4 to 20 mA (Resolution: 1/4,000) | FP0-A04V | AFP04121 |
| | | FP0-A04I | AFP04123 |
| FP0 Thermocouple Unit | K, J, T and R thermocouple, Resolution: 0.1°C | FP0-TC4 | AFP0420 |
| | K, J, T and R thermocouple, Resolution: 0.1°C | FP0-TC8 | AFP0421 |

4 Link and communication units

| Product name | Specifications | Power supply voltage | Product number | Part number |
|--------------------------------------|--|----------------------|----------------|-------------|
| FP0 CC-Link Slave Unit | This unit is for making the FP0 function as a slave station of the CC-Link. Only one unit can be connected to the furthest right edge of the FP0 expansion bus. Note: Accuracy will change if an FP0 thermocouple unit is used at the same time. For details, please refer to the catalog or to the CC-Link Unit manual. | 24 V DC | FP0-CCLS | AFP07943 |
| FP0 I/O Link Unit | This is a link unit designed to make the FP0 function as a station to MEWNET-F (remote I/O system). | 24 V DC | FP0-IOL | AFP0732 |
| KS1 Signal Converter | RS232C/RS485 data can be easily monitored by LAN. | 24 V DC | — | AKS1202 |
| C-NET Adapter (for computer side) | This is an RS485 adapter designed to allow use of the computer link function for connecting to a network-connected PLC via C-NET from a host computer. | 100 to 240 V AC | — | AFP8536 |
| | | 24 V DC | — | AFP8532 |
| FP Web-Server 2 Unit | Unit for connecting FP series or RS232C interface device and Ethernet Web-server function and E-mail sending function | 24 V DC | FP-WEB2 | AFP0611 |

5 Power supply unit and others

| Product name | Specifications | Product number | Part number |
|-----------------------|---|----------------|-------------|
| FP0 Power Supply Unit | Input voltage: 100 to 240 V AC Output capacity: 24 V DC, 0.7 A | FP0-PSA4 | AFP0634 |
| FP Memory Loader | Data clear type | — | AFP8670 |
| | Data hold type | — | AFP8671 |

6 Programming tools

| Product name | Specifications | Part number |
|--|--|---|
| Windows version tool software Control FPWIN Pro Ver.6 (Conforms to IEC61131-3) (FP0R is compatible with Ver. 6.1 or later.) | Japanese version, Full type | CD-ROM for Windows AFPS50160 |
| | English version, Full type | CD-ROM for Windows AFPS50560 |
| Windows version tool software Control FPWIN GR (FP0R is compatible with Ver. 2.8 or later.) | Japanese tool kit with cable | CD-ROM for Windows, with cable (AFC8503) for connection of FP to DOS/V PC AFPS10122 |
| | English version, Full type | CD-ROM for Windows AFPS10520 |
| | English version, Small type | CD-ROM for Windows AFPS11520 |
| | Chinese version, Full type | CD-ROM for Windows AFPS10820 |
| | Korean | CD-ROM for Windows AFPS10920 |
| Handheld programmer | Not available for FP0R. Also the discontinued models (AFP1113V2 and AFP1114V2) are not compatible with FP0R. (They are compatible with FP0.) | |

7 Options and maintenance parts

| Product name | Specifications | Part number |
|--|--|---|
| FP Memory Loader (Note) | Data clear type | AFP8670 |
| | Data hold type | AFP8671 |
| Terminal screwdriver | Relay output type Necessary when wiring terminals block (Phoenix). | AFP0806 |
| Molex connector pressure contact tool | Necessary when wiring relay output type and Molex connectors. (MOLEX: 57189-5000) | AFP0805 |
| Multi-wire connector pressure contact tool | Necessary when wiring transistor output type connectors. | AXY52000FP |
| FP0 Slim type Mounting plate | Screw-stop attachment plate for FP0 expansion unit. Slim model. | AFP0803 (set for 10) |
| FP0 Flat type Mounting plate | Screw-stop attachment plate for FP0 control unit. Flat model. | AFP0804 (set for 10) |
| Relay output Molex type I/O cable | Loose-wiring cable (9 leads) with molex socket attached at one end, AWG20, 0.5 mm ² , 1 set: 2 cables (blue & white). | Length: 1 m 3.3 ft AFP0551 (2 cables set) |
| | | Length: 3 m 9.8 ft AFP0553 (2 cables set) |
| Transistor output type I/O Cable | Loose-wiring cable (10 leads) with connectors attached at one end, AWG22, 0.3 mm ² , 1 set: 2 cables (blue & white) | Length: 1 m 3.3 ft AFP0521 (2 cables set) |
| | | Length: 3 m 9.8 ft AFP0523 (2 cables set) |
| Flat cable connector set | Flat cable connector set (10 leads) | AFP0808 (including 4 pieces) |
| Terminal socket | Attaches to relay output and terminal block type. Maintenance part | AFP0802 (2 sokets per pack) |
| Molex socket | Attaches to relay output and Molex connector types. Maintenance part | AFP0801 (2 sokets per pack) |
| Wire-press socket | Attaches to transistor output type. Maintenance part | AFP0807 (2 sokets per pack) |
| Power cable for control unit | Attaches to FP0R control unit. Maintenance part Length: 1 m 3.3 ft | AFPG805 (1 cable per pack) |
| Power cable for expansion unit | Attaches to expansion unit. Maintenance part Length: 1 m 3.3 ft | AFP0581 (1 cable per pack) |

Note: FP0R is compatible with Ver. 2 or later.

DIMENSIONS (Unit: mm in)

Control units and Expansion units * For the relay output type, the terminal block type is listed as the representative type.

Control units

C10RS, C10RM, C10CRS, C10CRM, C10MRS, C14RS, C14RM, C14CRS, C14CRM and C14MRS

Expansion units

E8RS, E8RM, E8YRS, E16RS and E16RM

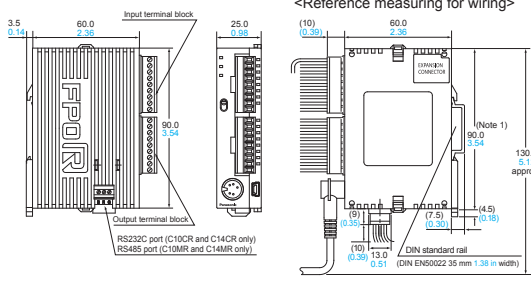

Terminal array

| | C10RS/C10RM | C14RS/C14RM | E8RS/E8RM | E16RS/E16RM/E8YRS |
|--------|-------------|-------------|-----------|-------------------|
| Input | X0 | X0 | X0 | X0 |
| | X1 | X1 | X1 | X1 |
| | X2 | X2 | X2 | X2 |
| | X3 | X3 | X3 | X3 |
| | X4 | X4 | X4 | X4 |
| | X5 | X5 | X5 | (NC) |
| Output | (NC) | (NC) | (NC) | (NC) |
| | (NC) | (NC) | (NC) | (NC) |
| | (NC) | (NC) | (NC) | (NC) |
| | (NC) | (NC) | (NC) | (NC) |
| | (NC) | (NC) | (NC) | (NC) |
| | (NC) | (NC) | (NC) | (NC) |
| | COM | COM | COM | COM |

Notes: 1) DIN rail is attached on the center of the unit.
2) The AFP0RE8YRS is not equipped with an input terminal block.

Control units

C16T, C16P, C16CT, C16CP, C16MT and C16MP

Expansion units

E16T, E16P, E8X, E8YT and E8YP

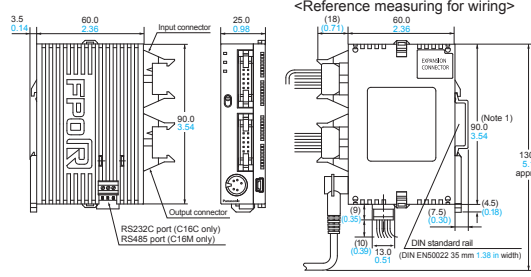

Terminal array

Input (8 points / common)

| | |
|-----|-----|
| X0 | X1 |
| X2 | X3 |
| X4 | X5 |
| X6 | X7 |
| COM | COM |

Output (8 points / common)

| | |
|------|------|
| Y0 | Y1 |
| (NC) | (NC) |
| (NC) | (NC) |
| (NC) | (NC) |
| (NC) | (NC) |
| (NC) | (NC) |
| (NC) | (NC) |
| (NC) | (NC) |
| (+) | (-) |

RS232C port Terminal array

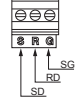

RS485 port Terminal array

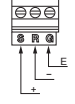

Note: Two COM terminals on the input circuit are connected inside the unit.

Control units

C32T, C32CT, C32P, C32CP, C32MT, C32MP, T32CT, T32CP, T32MT, T32MP, F32CT, F32CP, F32MT and F32MP

Expansion units

E32T, E32P, E16X, E16YT and E16YP

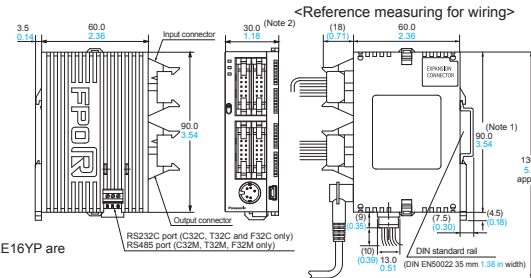

Terminal array

Input (16 points / common)

| | | | |
|-----|-----|-----|-----|
| X0 | X1 | X8 | X9 |
| X2 | X3 | XA | XB |
| X4 | X5 | XC | XD |
| X6 | X7 | XE | XF |
| COM | COM | COM | COM |

Output (16 points / common)

| | | | |
|-----|-----|-----|-----|
| Y0 | Y1 | Y8 | Y9 |
| Y2 | Y3 | YA | YB |
| Y4 | Y5 | YC | YD |
| Y6 | Y7 | YE | YF |
| (+) | (-) | (+) | (-) |

RS232C port Terminal array

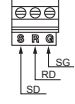

RS485 port Terminal array

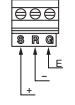

Notes: 1) Four COM terminals on the input circuit are connected inside the unit.
2) Two (+) terminals and two (-) terminals on the output circuit are connected respectively inside the unit.

FP0 Analog I/O Unit and D/A Converter Unit

FP0 A/D Converter Unit and Thermocouple Unit

FP Web-Server 2 Unit

FP0 Power Supply Unit

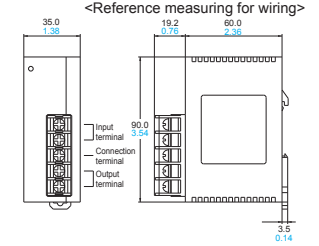
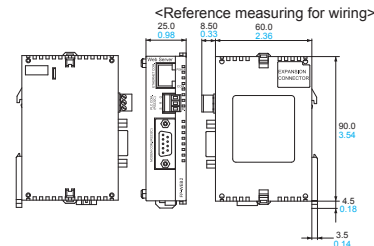
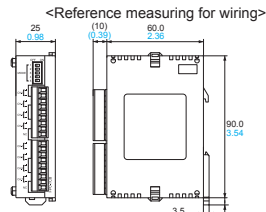
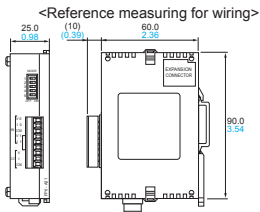

External Dimensions During Expansions

Top view (with DIN rail attached)

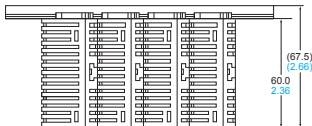

Front view

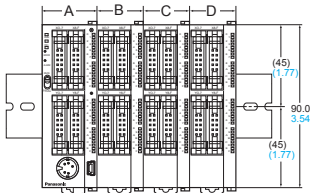

A + B + C + D dimensions (mm in)

| Control unit | A + B + C + D dimensions (mm in) | | | |
|--|----------------------------------|------------|------------|-------------|
| | A | A→B | A→C | A→D |
| C10RS C16T C10CRS C16CT C10RM C16P C10CRM C16CP C10MRS C16MT C14RS C16MP C14CRS C14RM C14CRM C14MRS | 25 0.98 | 50 1.97 | 75 2.95 | 100 3.94 |
| C32T C32MT C32CT C32MP C32P T32MT C32CP T32MP T32CT F32MT T32CP F32MP F32CT F32CP | 30 1.18 | 55 2.17 | 80 3.15 | 105 4.13 |



www.realtechotomasyon.com.tr